



PENDANT
"CIRCLES"

INSTRUCTION PACKAGE PENDANT “CIRCLES”



SWAROVSKI ELEMENTS

Supplies & Tools

Article	Product Group	Article No.	Amount	Size	Color	Color Code
	Pendants	6039	2 pcs.	25mm	Crystal Bronze Shade	001 BRSH
	Pendants	6039	1 pc.	25mm	Crystal Silver Shade	001 SSHA
	Pendants	6039	1 pc.	38mm	Crystal Silver Night	001 SINI

Supplies
Cotton waxed cord, black, Ø 1.5mm, 1.4m

Tools
Glue
Scissors
Tweezers

Level of design: INTERMEDIATE

Have also a look at the **text instruction** at the last page!

STEP 1

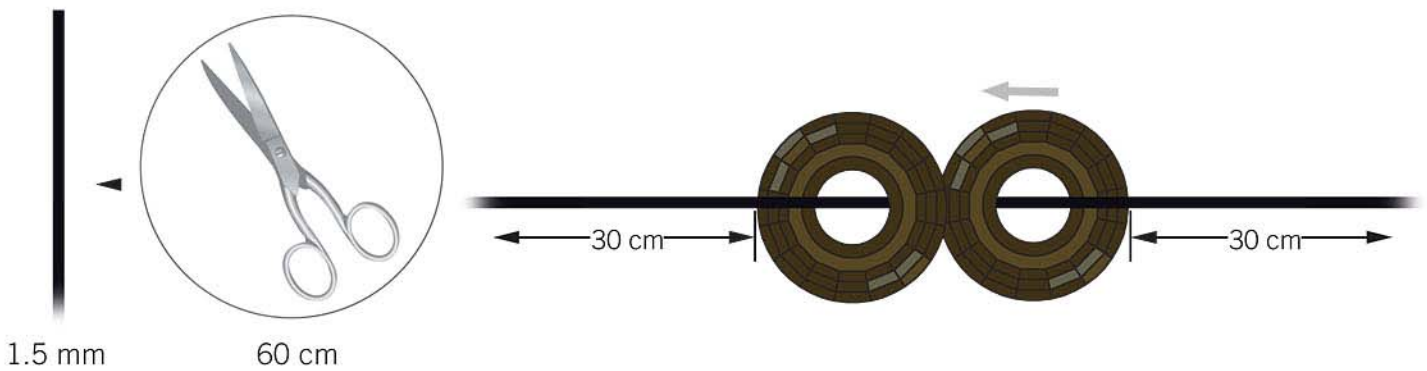

STEP 2

Repeat step x1:



STEP 3

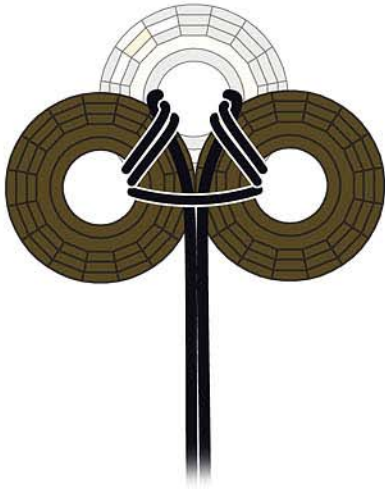
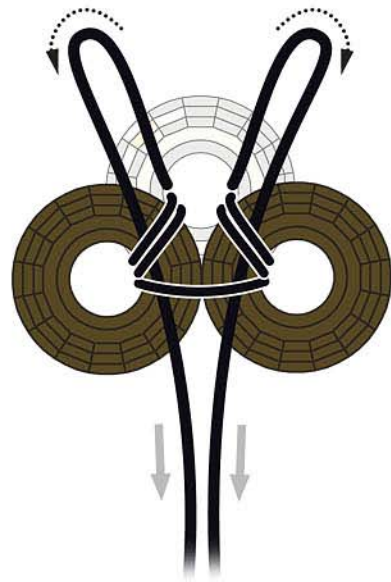
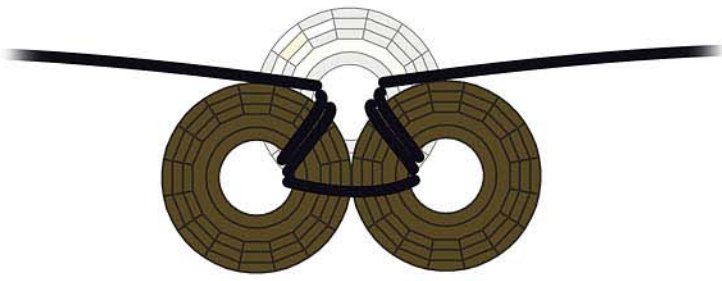

STEP 4

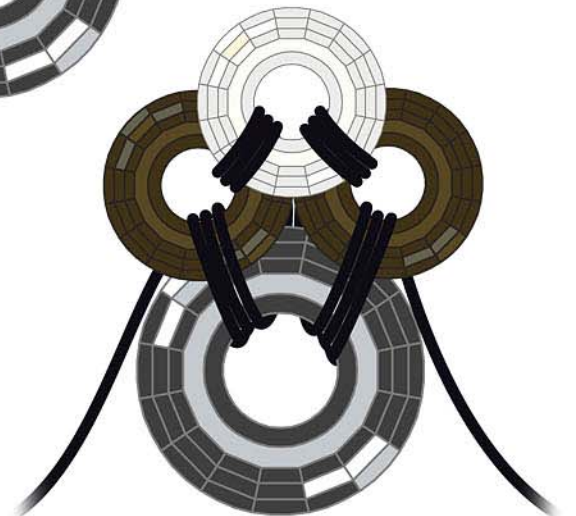
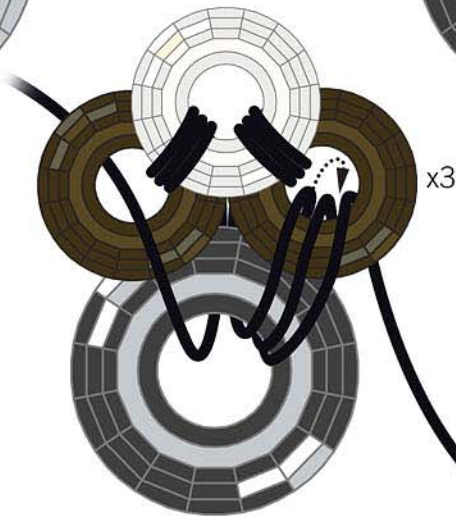
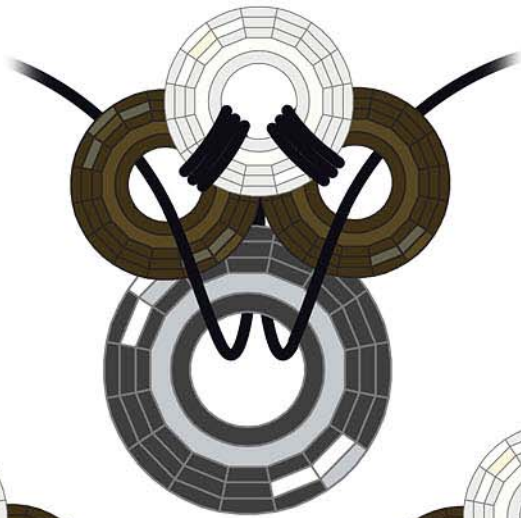
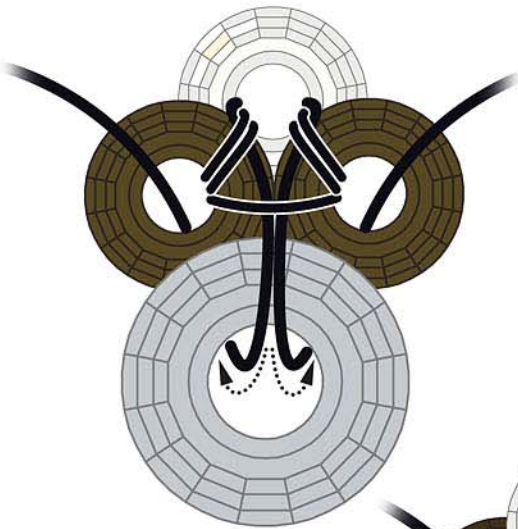

Repeat

STEP 5

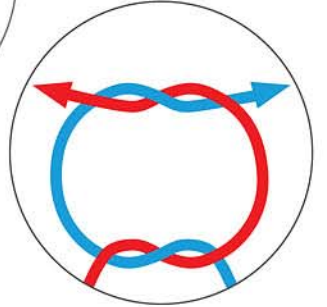
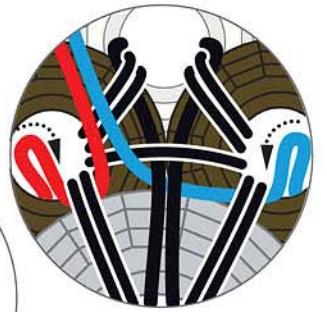
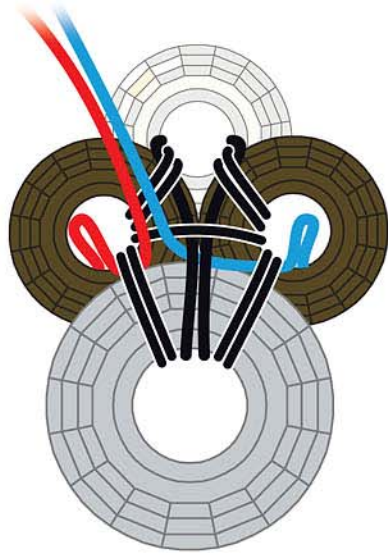
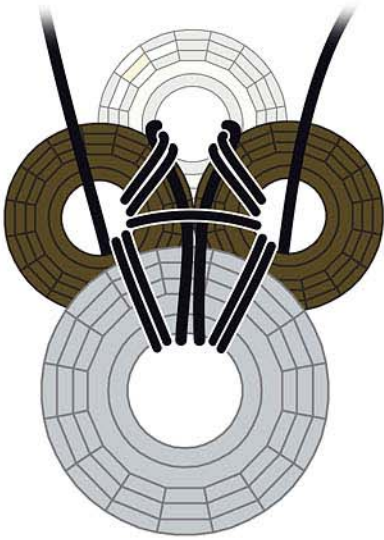

STEP 6

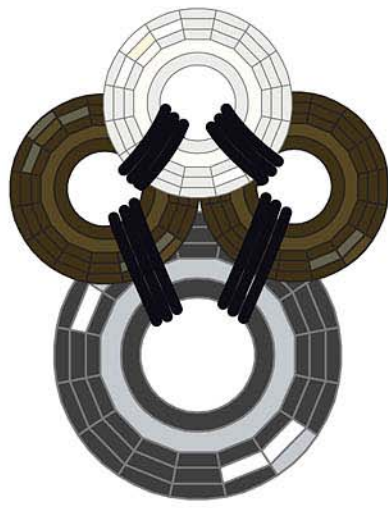
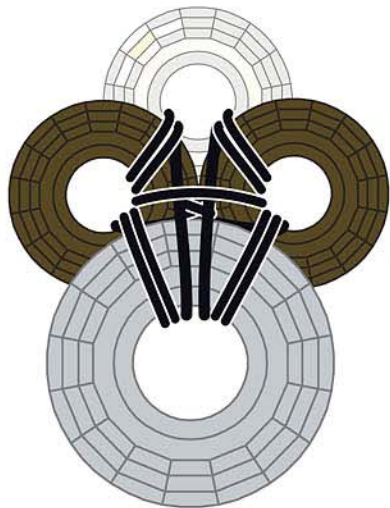
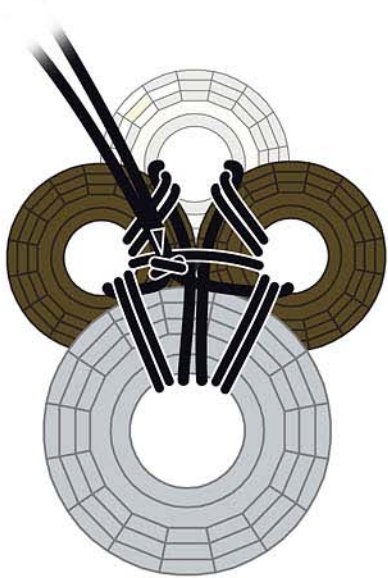

STEP 7

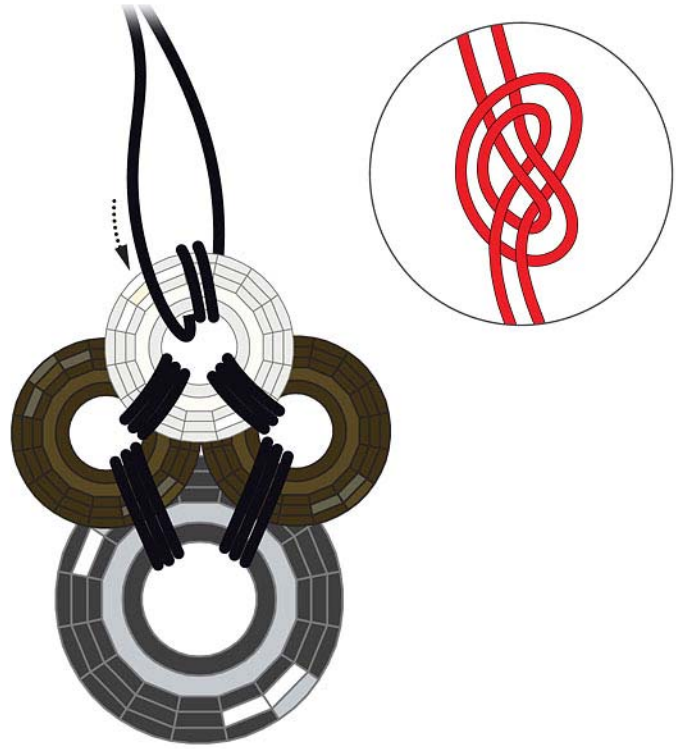
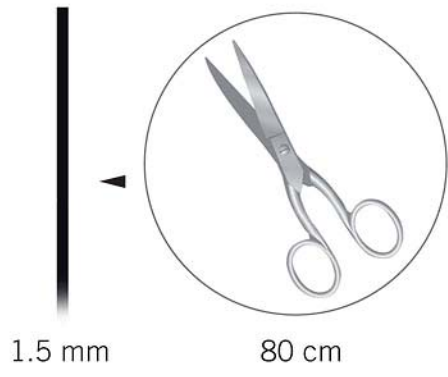

INSTRUCTION PACKAGE PENDANT “CIRCLES”



- STEP 1: Cut 60cm of 1.5mm cotton waxed cord and slide two Swarovski Pendants article 6039 25mm Crystal Bronze Shade onto it.
- STEP 2: Wrap the cord around another Swarovski Pendant article 6039 25mm Crystal Silver Shade three times. Repeat this step to wrap the other end of the cord around this Pendant as well.
- STEP 3: Turn the Pendants over and slide the cord ends underneath the wrapped cord from step 2 as shown in the illustrations.
- STEP 4: Turn the Pendants over again and add a Swarovski Pendant article 6039 38mm Crystal Silver Night. Slide the cord end through it and wrap it around the Pendants. Repeat for the other cord end.
- STEP 5: Turn the Pendants over again and slide the cord ends underneath the previously wrapped cord, (use tweezers to help slide the cord ends through). Tie a double knot with the cord ends.
- STEP 6: Put some glue onto the knot and let dry. Cut off the remaining cord ends and hide the knot beneath the wrapped cord as shown in the illustration. Turn the pendant over.
- STEP 7: Cut 80cm of 1.5mm cotton waxed cord and wrap it in the middle of the Swarovski Pendant article 6039 25mm Crystal Silver Shade and tie a knot.