

CREATE  
YOUR STYLE  
with SWAROVSKI ELEMENTS







DESIGN PROJECT

EASTER  
NAPKIN RING  
“CLASSY HEN”

# EASTER NAPKIN RING "CLASSY HEN"



## SWAROVSKI ELEMENTS

Article	Product Group	Article No.	Amount	Size	Color	Color Code
	Fancy Stones	4228	1 pc.	10x5mm	Crystal	001
	Fancy Stones	4328	3 pcs.	13x7.8 mm	Crystal	001
	Fancy Stones	4739	1 pc.	14x11 mm	Crystal	001
	Fancy Stones	4757	1 pc.	14x8.5mm	Crystal	001
	Fancy Stones	4790	1 pc.	18x7.5mm	Crystal	001

## Supplies & Tools

### Supplies

Modelling compound, white, 250g (Kerami plast)

### Tools

Cardboard, 13x12cm  
Cutter  
Double sided tape  
1x Plastic folder  
2x Rolling pin  
Sand paper  
Scissors  
Sheet of paper, Din A4  
Shot glass, 3.8cm  
Tooth brush  
Tweezers

Level of design: BEGINNER

Have also a look at the **text instruction** at the last page!

## STEP 1

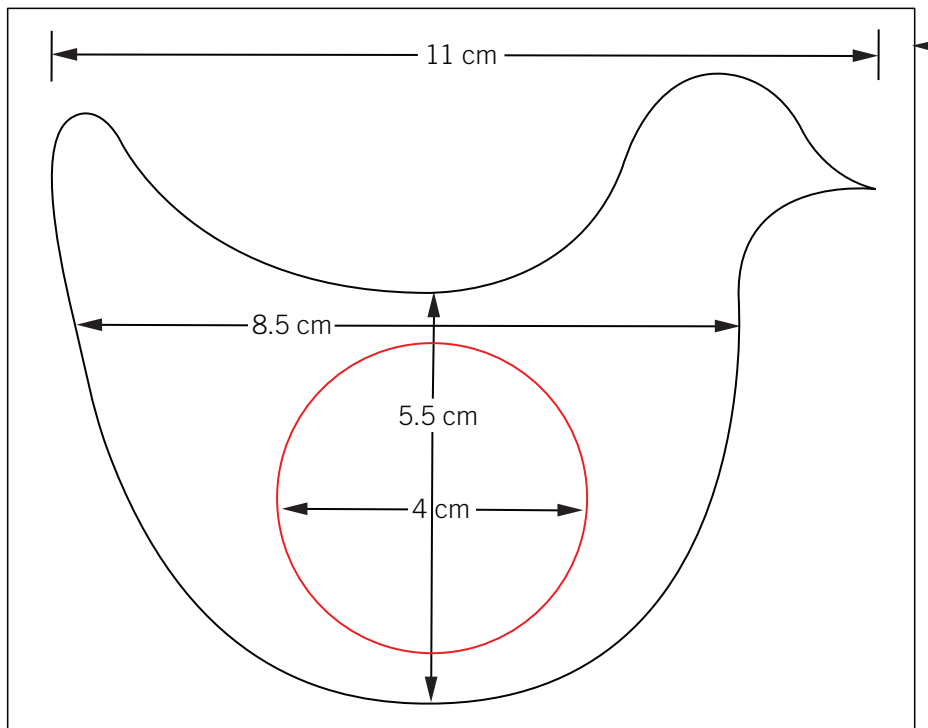

STEP 2

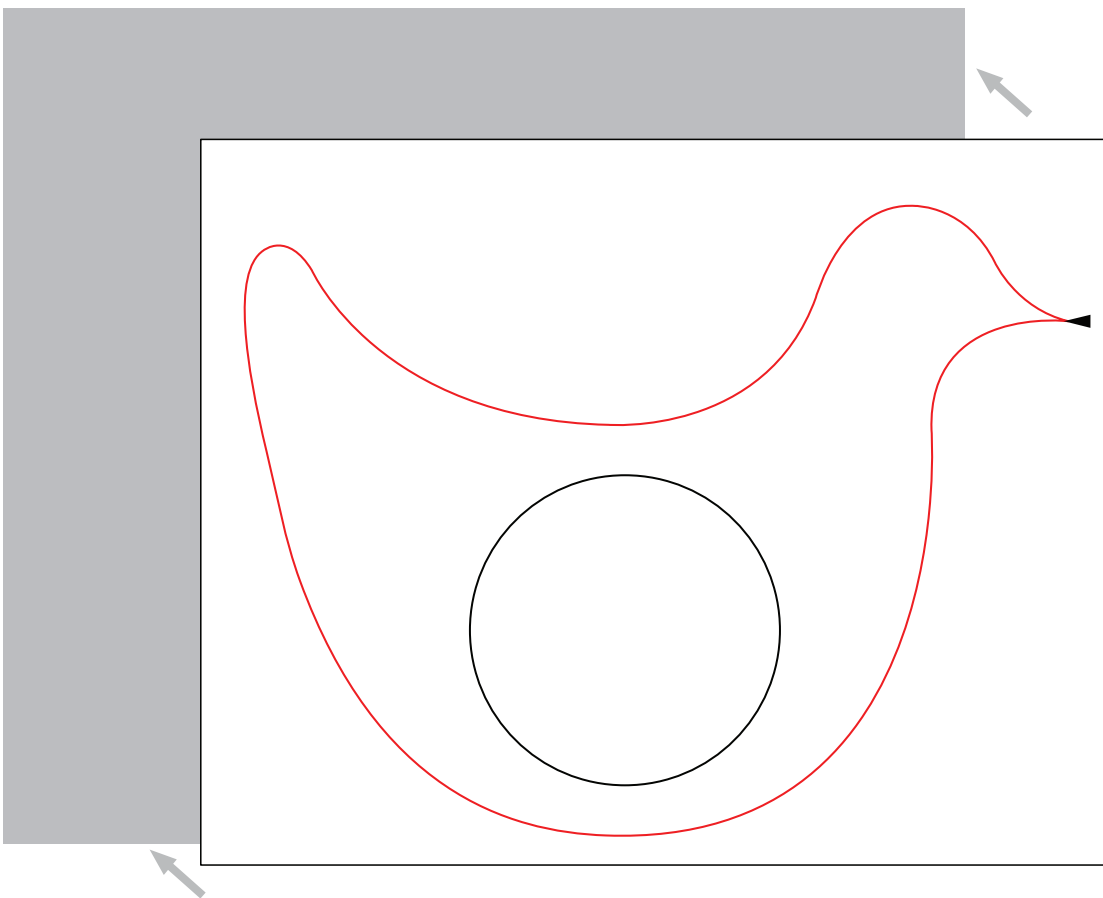
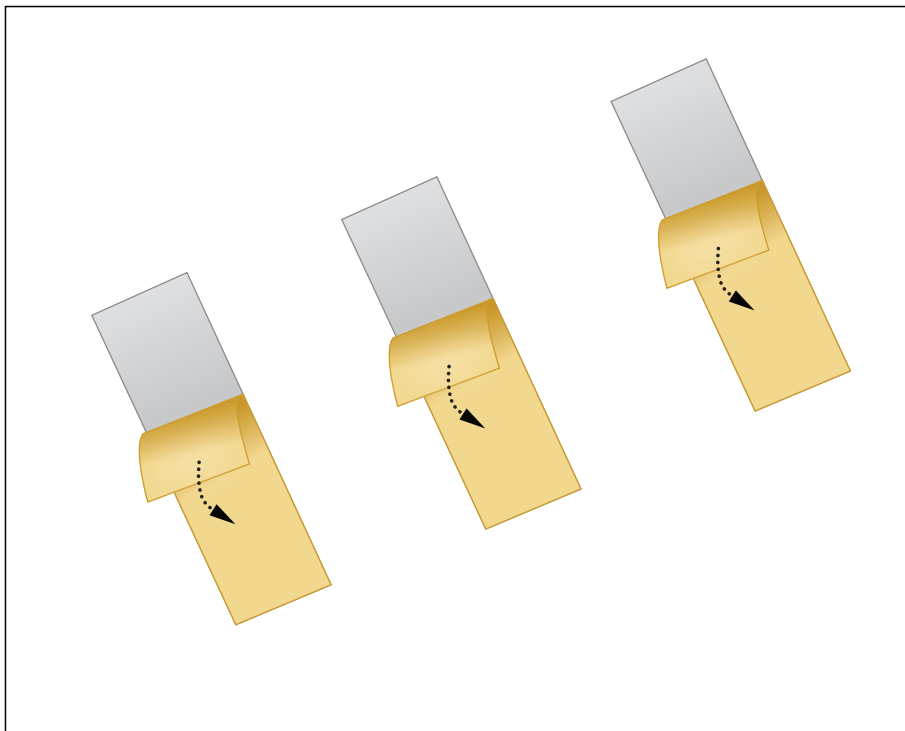

STEP 3

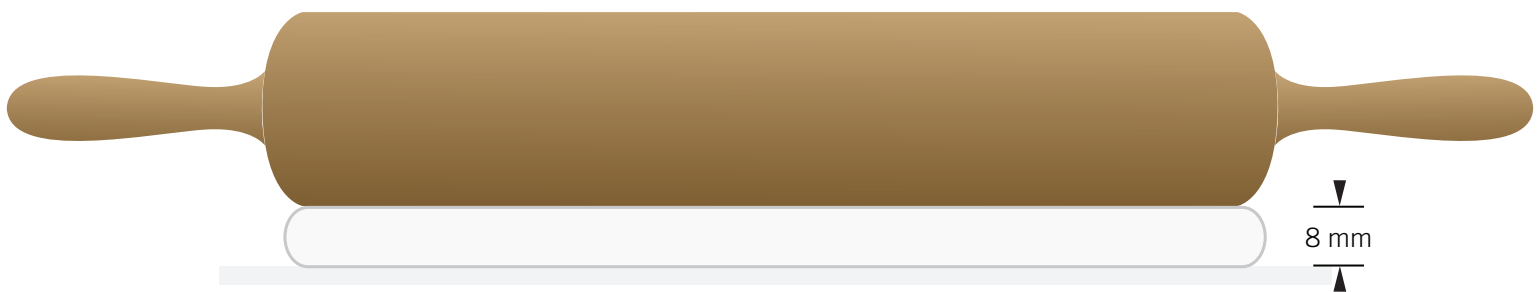
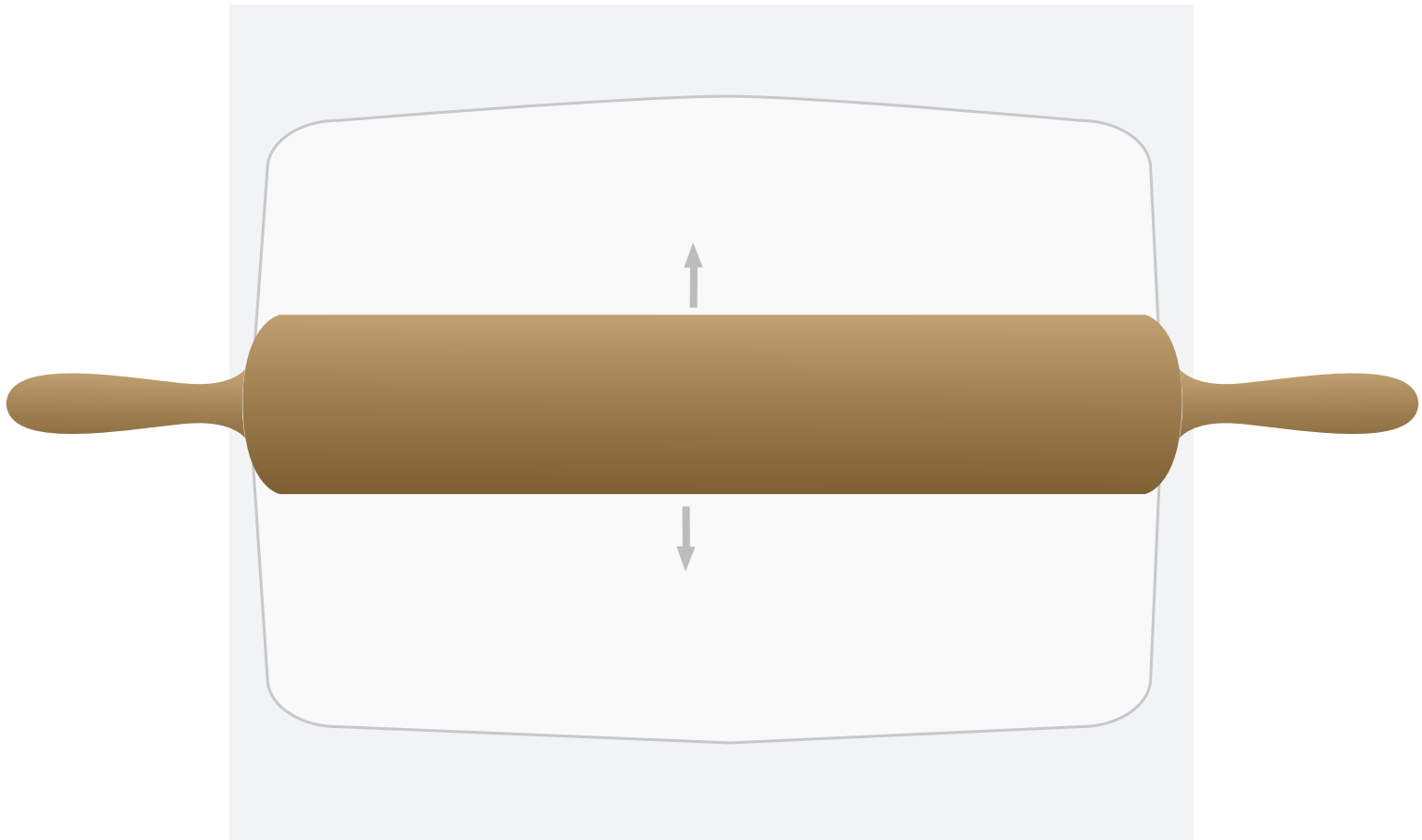

STEP 4

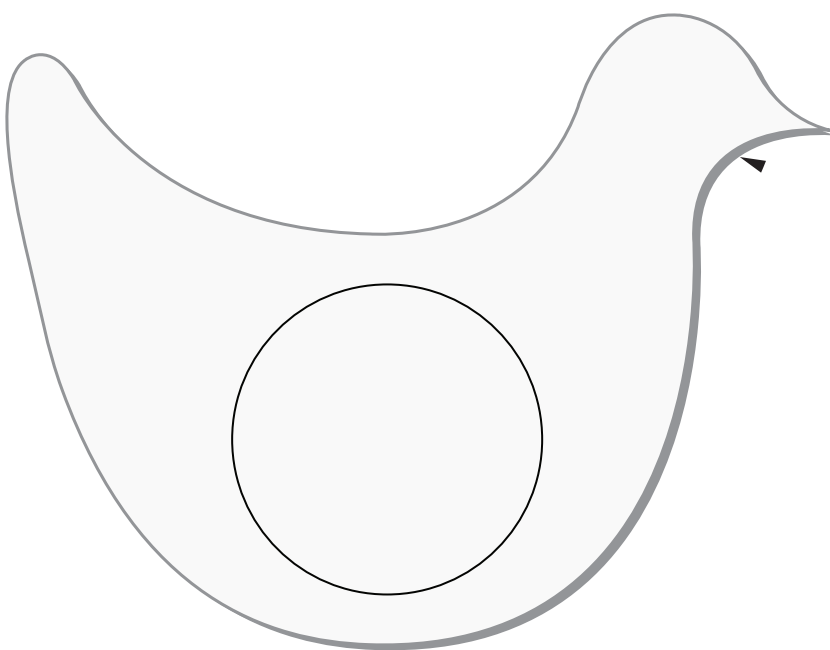
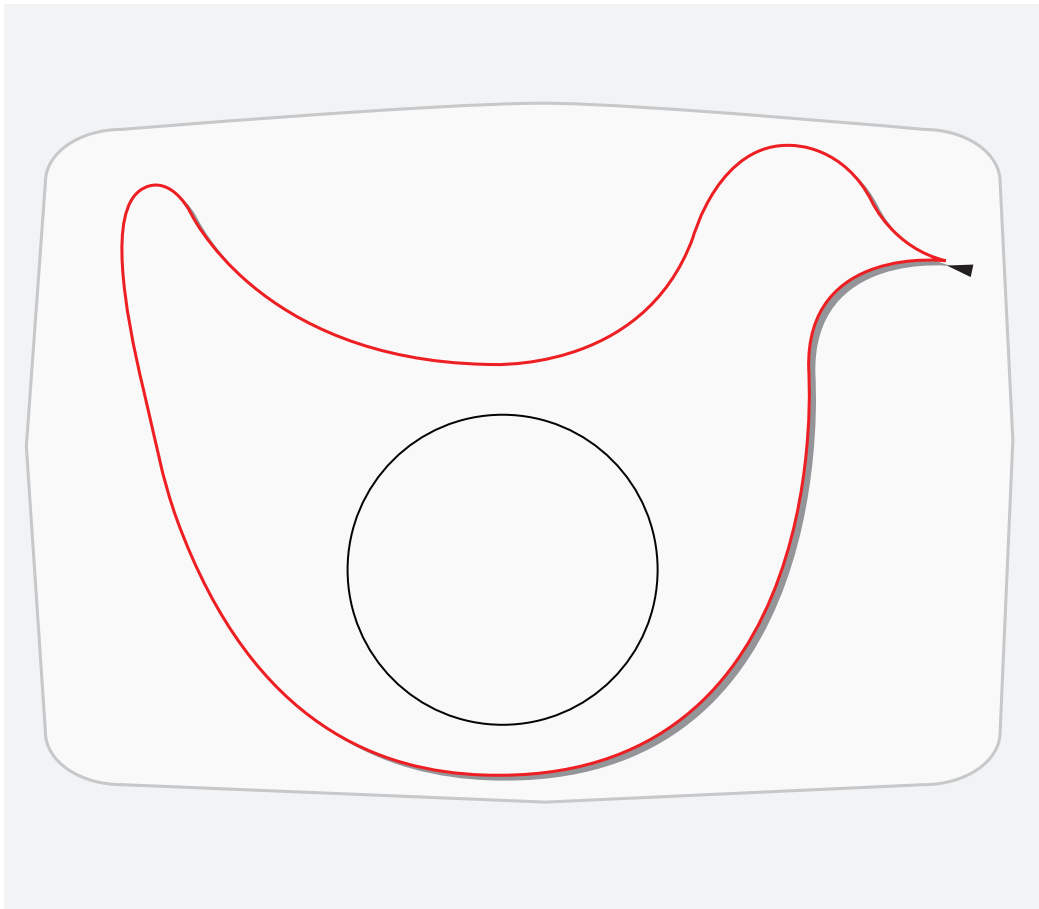

STEP 5

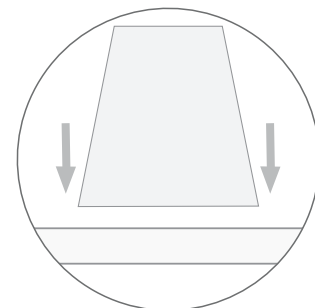
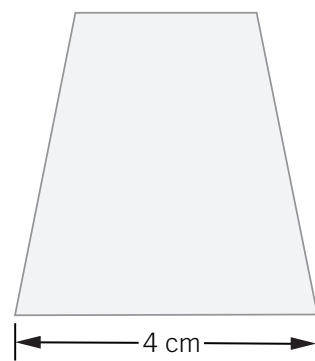
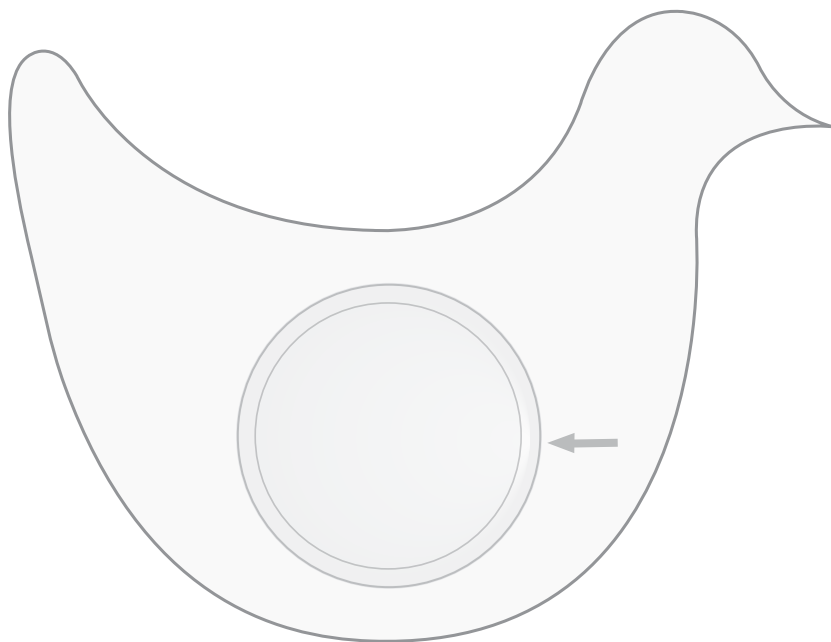

STEP 6

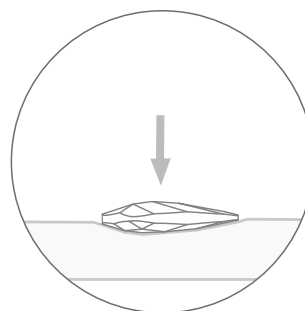
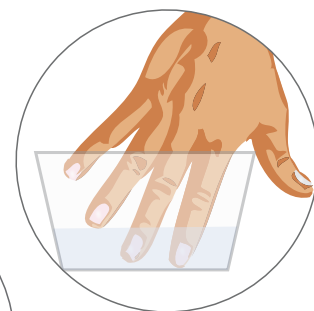
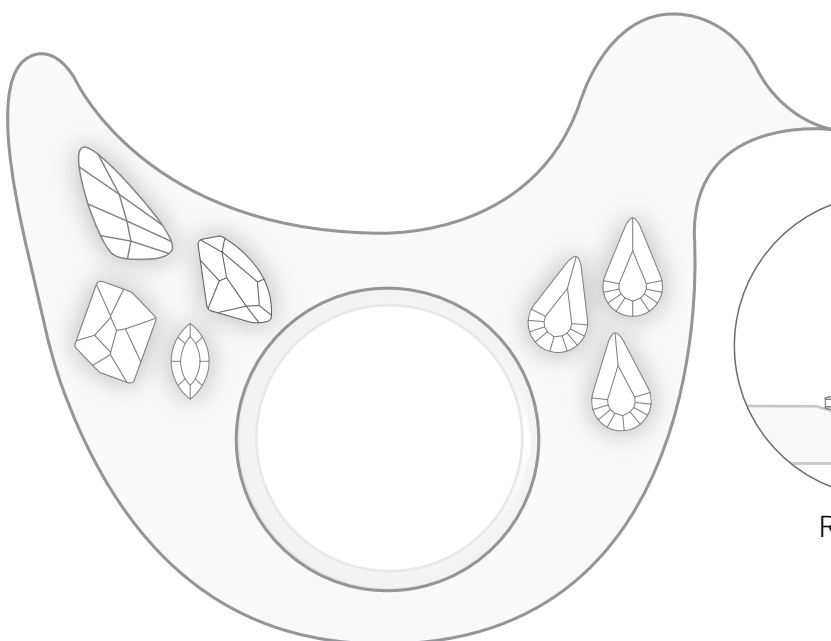

Repeat x6

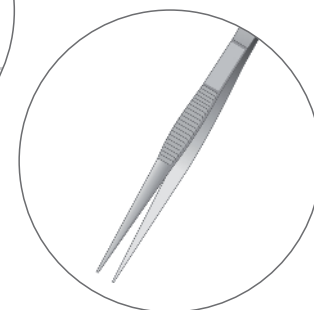

STEP 7

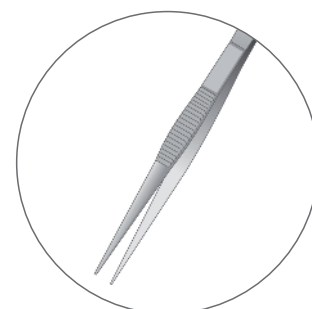
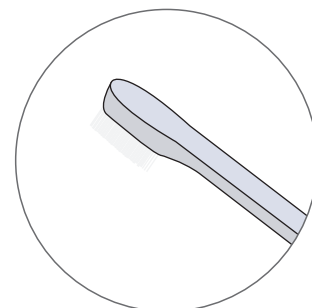
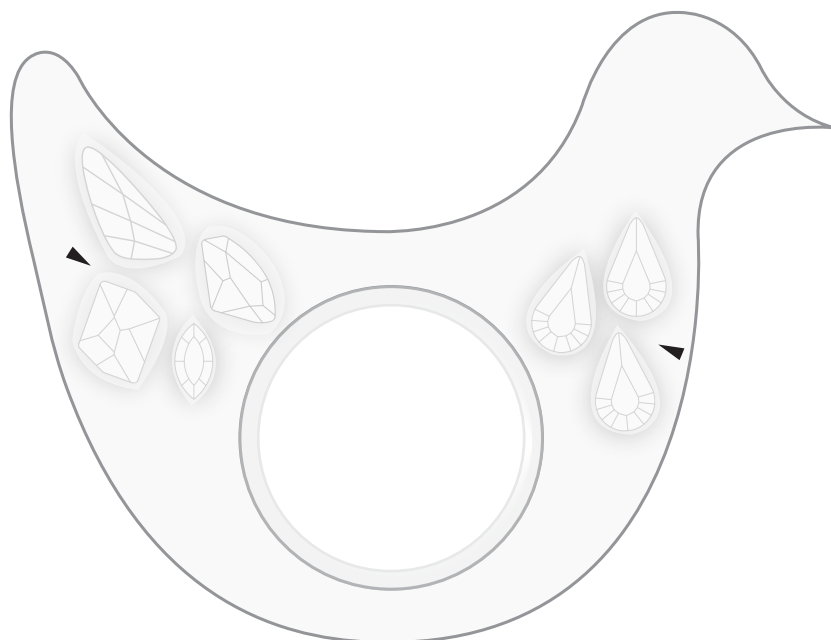

STEP 8

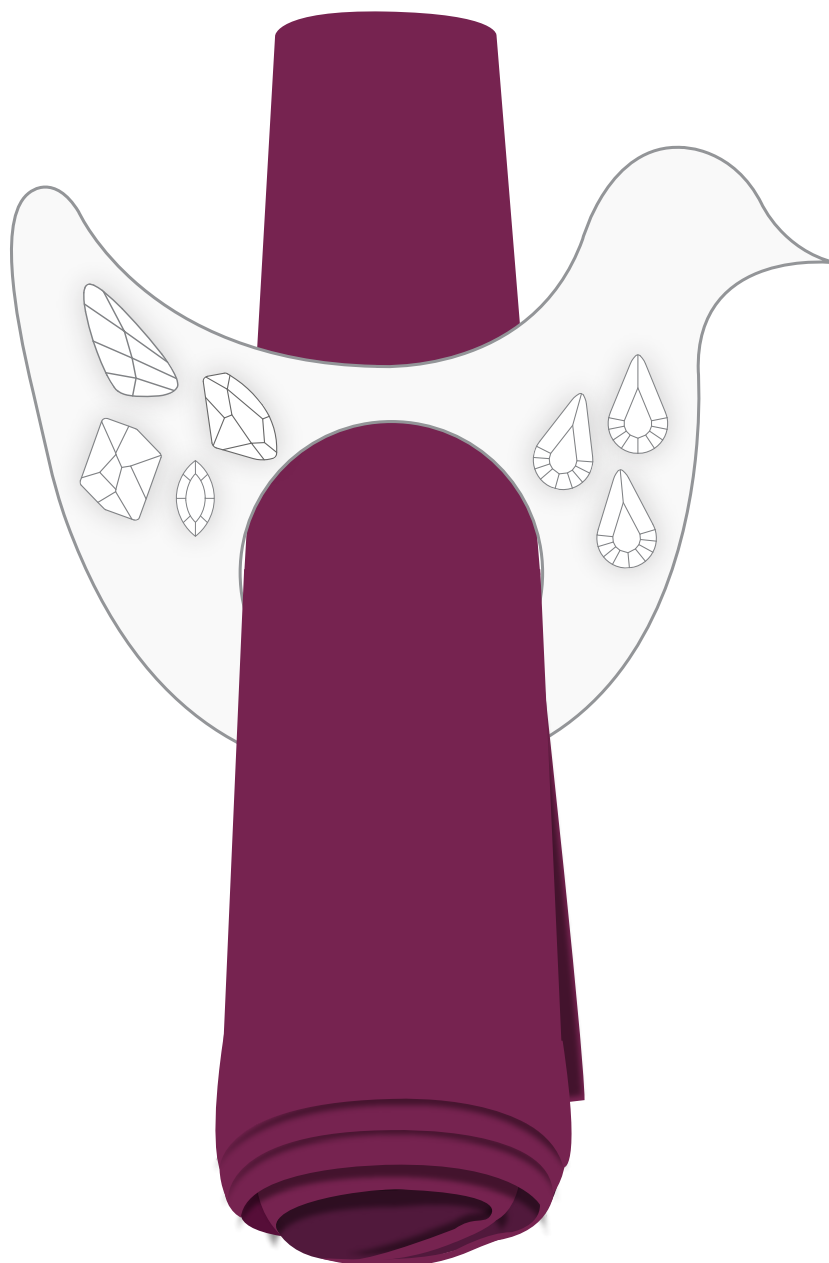
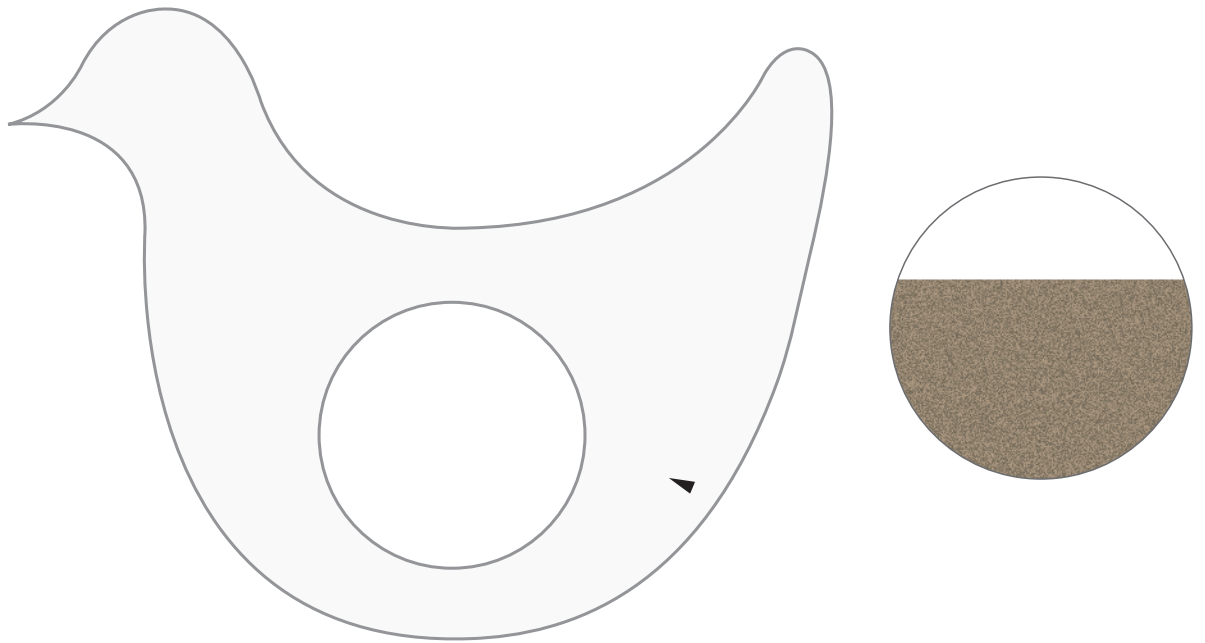

# EASTER NAPKIN RING "CLASSY HEN"



- STEP 1: Cut out the pattern and apply double sided tape to the back.
- STEP 2: Adhere the pattern onto a piece of cardboard and cut out the pattern.
- STEP 3: Put the modelling compound onto the plastic folder and roll it down flat using a rolling pin to a thickness of 8mm.
- STEP 4: Cut out the outer shape marked with red outline using a side cutter. Carefully mould the edges with a bit of water to smooth them down as shown in the illustration with this step.
- STEP 5: Use a small glass with an approximate diameter of 4cm and place it over the centre and cut into the plastic compound to create a hole as shown in the illustration with this step.
- STEP 6: Mould the inner edges with a bit of water to soften them. Press the seven fancy stones from the SWAROVSKI ELEMENTS assortment into the plastic compound using tweezers as shown. Apply a small amount of water to mould them in properly.
- STEP 7: Use a toothbrush to clean the SWAROVSKI ELEMENTS and fix them properly with the help of tweezers as depicted in the illustrations.
- STEP 8: Smooth the compound as necessary by gently sanding with sandpaper. You can insert your napkin through the centre hole.